

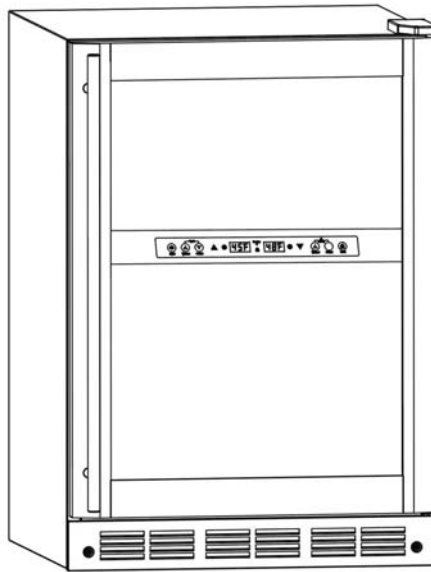

**BEVERAGE COOLER
WITH DUAL TEMPERATURE ZONES
INSTRUCTION MANUAL**

Model No.: 155D



Quality check – Sydney warehouse

- Package opened and appliance checked for damage
- Handle location correctly marked on carton
- Operating instructions inside appliance
- Appliance starts on power on

Pass Fail

Pass	Fail

Operating touch controls

- Lock / unlock button
- Lower zone temperature up
- Lower zone temperature down
- Upper zone temperature up
- Upper zone temperature down
- Lights turn on
- Change Celsius to Fahrenheit and back

Appliance auto locks after 60 seconds

.....
Checked by

To ensure proper use of this appliance and your safety, please read the following instructions completely before operating this appliance.

Parts Diagram

MODEL NO.: 155D

- 1) Interior Lights
- 2) DC Electric Fan
- 3) Zone Partition
- 4) Inner rear
- 5) Wine Shelf
- 6) Door Handle
- 7) Partition Gasket
- 8) Tempered Glass Door

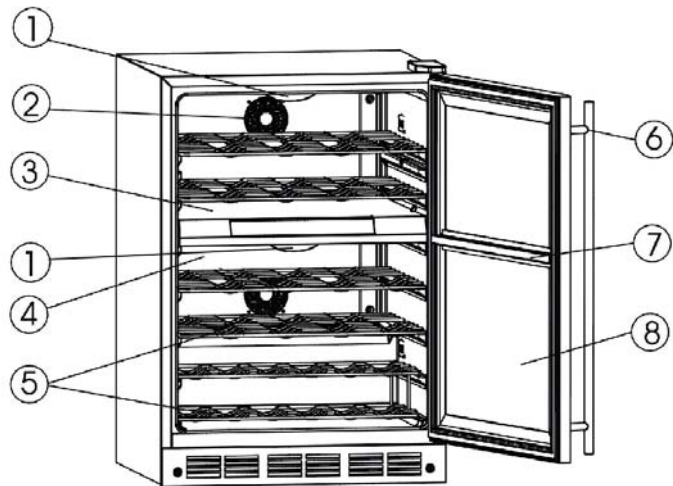

(Touch-Screen Control Panel is on the front of the Glass Door.)

SPECIFICATIONS – Model # 155D

Product Description	Built-In Wine & Beverage Cooler With Dual Temperature Zones		
Model No.	155D		
Unit Dimensions (millimeters)	Width	Height	Depth
	595mm	873mm	600mm
Net Weight (kg)	46kg		

IMPORTANT SAFETY INSTRUCTIONS

⚡WARNING⚡	To reduce the risk of fire, electrical shock, or injury when using your appliance, follow these basic precautions:
<ul style="list-style-type: none">• Read all instructions before using the wine or beverage cooler.• This appliance is suitable for use in normal ambient indoor temperatures in Australia.• DANGER or WARNING: Risk of child entrance.• To avoid the possibility of child entrance, please take the following precautions before throwing out the appliance.<ul style="list-style-type: none">- Remove all doors from the unit.- Leave the shelves in place so that children may not easily climb inside.• Never allow children to operate, play with, or crawl inside the appliance.• Do not use mechanical devices or other means to defrost, other than those recommended by the manufacturer.• Do not damage the refrigerant circuit.• Keep ventilation openings, in the appliance enclosure or in the built-in structure, clear of obstruction.• Do not use electrical appliance inside the food storage compartments of the appliance unless they are of a type recommended by the manufacturer.• The appliance cannot be used in public transportation.• Not for camping use.• Never clean appliance parts with flammable fluids. The fumes can create a fire hazard or explosion.• Do not store or use gasoline or any other flammable vapors and liquids in the vicinity of this or any other appliance. The fumes can create a fire hazard or an explosion.• Try not to open the door too often, especially when the weather is hot and humid. Once you open the door, close it as soon as possible.• If the gasket is damaged or the door seal is poor, energy consumption is substantially higher. To restore efficiency, replace the gasket.• Every now and then check if the appliance is sufficiently ventilated (adequate air circulation behind the appliance).• The appliance should not be used by children without supervision. <p style="text-align: center;">-Save these instructions-</p>	

INSTALLATION INSTRUCTIONS

Before Using Your Appliance

- Remove the exterior and interior packing.
- Before connecting the appliance to the power source, let it stand upright for approximately 4 hours. This will reduce the possibility of a malfunction in the cooling system from improper handling during transportation.
- Clean the interior surface with lukewarm water using a soft cloth. (Cleaning instruction on page 9)

Free-Standing Installation

- This appliance is designed to be **installed built-in or free standing**.
- Locate the appliance away from direct sunlight and sources of heat (stove, heater, radiator, etc.). Direct sunlight may affect the acrylic coating and heat sources may increase electrical consumption. **This unit is not designed for use in a garage or any other outside installation.**
- Avoid locating the appliance in moist areas.
- Plug the appliance into dedicated, properly installed-grounded wall outlet. Do not under any circumstances cut or remove the third (ground) prong from the power cord. Any questions concerning power and/or grounding should be directed toward a certified electrician or an authorized service center. **This unit is not designed to be installed in an RV or used with an inverter.**
- After plugging the appliance into a wall outlet, turn the unit on and allow the unit to cool down for 3 ~ 4 hours before placing wine bottles or beverage cans in the appliance.

Built-In Installation`

The cutout dimension illustrated in figure (A) allows for door swing and access to the pull-out shelves when installed as a built-in appliance. If installing between frameless cabinets, a 13mm wide filler strip or side panel may be needed on hinge side. The filler strip will act as a spacer between the appliance case and adjacent cabinet door swing. The width of the opening must include the filter panels.

Note:

The door should protrude at least 25mm beyond the surrounding cabinets.

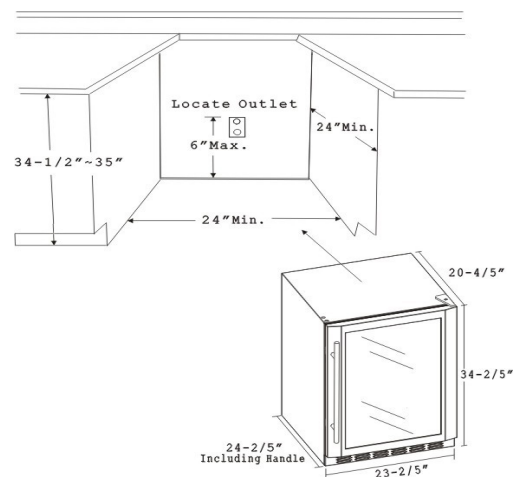

Figure A

The cutout depth must be 610mm.

Electrical Connection

⚡WARNING⚡

Improper use of the grounded plug can result in the risk of electrical shock. If the power cord is damaged, have it replaced by an authorized service center.

If the supply cord is damaged, it must be replaced by the manufacturer or its service agent or a similarly qualified person in order to avoid a hazard.

The appliance must be properly connected to an electrical power supply.

This appliance requires a standard 220-240VAC/50Hz electrical outlet with three-prong ground.

The cord should be secured behind the appliance and not left exposed or dangling to prevent accidental injury.

The supply plug shall be accessible after installation.

Never unplug the appliance by pulling the power cord. Always grip the plug firmly and pull straight out from the power point.

Do not use an extension cord with this appliance. If the power cord is too short, have a qualified electrician or service technician install an outlet near the appliance. Use of an extension cord can negatively affect the performance of the unit.

DISPOSAL

Do not dispose this product as unsorted municipal waste. Collection of such waste separately for special treatment is necessary.

- Contact you local government for information regarding the collection systems available.
- If electrical appliances are disposed of in landfills or dumps, hazardous substances can leak into the groundwater and get into the food chain, damaging your health and well-being.

APPLIANCE FEATURES

Two Temperature Zones

- There are two zones in this appliance divided by a partition.
- Each zone has its independent temperature control and display.
- Each of the two zones can be used to store wine bottles or beverages.

Interior Light

- Each zone has its own interior light, which can be switched on or off by pressing the pad  (light) on the control panel. Long-life and high efficiency LEDs are installed for durability and energy saving.

Upper Zone

- There are two wine shelves of full depth in the upper zone. Each shelf can hold up to 8 bottles with the bottle necks alternating front to back.
- The second supporting guide in the upper zone (counted from top, see illustration "A" on this page) is not designed for wine shelves. It is for beverage shelves only.

Lower Zone

- There are also two wine shelves of full depth in the lower zone. Each shelf can hold up to 8 bottles with the bottle necks alternating front to back.
- The bottom rack in the lower zone, which consists of two stories, each holds up to 6 bottles with bottle necks facing the front (see illustration below on this page).

Engaged Wine Shelves

- All the wine shelves and glass shelves of full depth have tabs to engage the cabinet on both sides.
- Any of the shelves can be removed to accommodate larger bottles.

To Remove a Shelf:

- Remove all bottles from the shelves.
- Lift the shelves upwards and then gently pull out the shelves.

To Replace a Shelf:

- Place the sides of the shelves back onto the supporting guides of the cabinet and push back until the shelf tabs slide into place.

NOTE: Ensure that the tabs are firmly engaged in place before storing any bottles.

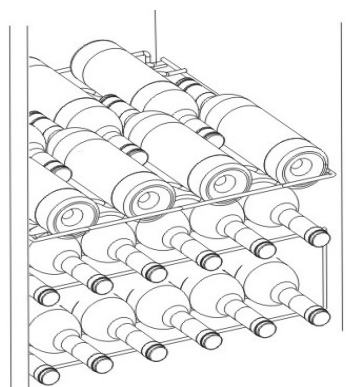
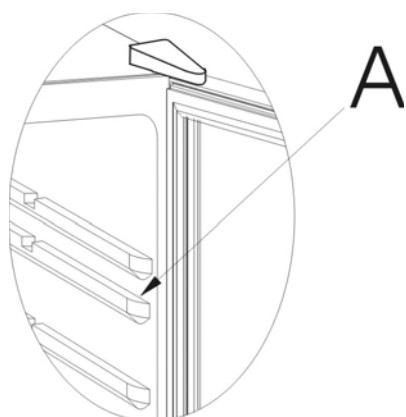

OPERATING YOUR APPLIANCE

Temperature Control and Display



1. The temperatures in upper zone and lower zone can be independently controlled and displayed.
2. The temperature in either zone can be controlled between 39°F to 61°F (4°C to 16°C).
3. The temperature display, indicator ❄️, control pads ▲ (warmer) and ▼ (colder) near the symbol ▲ (left side) are for upper zone of the wine cooler.
4. The temperature display, indicator ❄️, control pads ▲ (warmer) and ▼ (colder) near the symbol ▼ (right side) are for lower zone of the wine cooler.
5. The indicators **Stand by** and 🔒, and the control pads 🔒 (lock) and ☀️ (light) are for both zones.

Indicators Lights

- When lit, the **Stand by** indicator light indicates that the unit is in the “Stand by” mode.
- When lit, the 🔒 indicator light indicates that all of the control pads are locked and no adjustment can be made to the unit.
- When lit, the ❄️ indicates that the corresponding zone is in the refrigeration cycle (compressor is running). The ❄️ indicator will go off once the desired temperature is reached. **Note: The ❄️ light will remain on and the compressor may continue to run for several minutes after the desired temperature is reached.**

Standby

1. When the unit is plugged in all of the display indicators will light for 3 seconds and an audible beep will be heard. The unit will automatically resume the previous settings from when the unit was unplugged. If the unit was previously in the “Stand By” mode when unplugged it will resume in the “Stand By” mode and the **Stand by** indicator will be lit.
2. You can manually set the unit to the “Stand By” mode by pressing and holding both the ▲ and ▼ pads simultaneously of the lower zone located on the right side of the control panel for approximately 3 seconds. The control pad must be “unlocked” to set the unit to the “Stand By” mode. The **Stand by** indicator light will illuminate to confirm this setting.

Lock and Unlock







The lock feature is designed to prevent the settings of your wine cooler from being adjusted accidentally. In order to adjust any of the settings you must unlock the control panel by pressing the “lock” pad for approximately 3 seconds. Once the unit is unlocked an audible beep will be heard and the “lock” indicator light will go out.

If no selection is made to adjust the unit in approximately one minute the control panel will automatically return to the “lock” mode.



To lock the unit manually press the “lock” pad.

Temperature setting



- Unlock the control panel by pressing the 🔒 pad for approximately 3 seconds. Once the control panel is unlocked an audible beep will be heard and the 🔒 indicator will go out.
- Under normal conditions the temperature display indicates the current temperature of the corresponding zone. When adjusting the temperature, the temperature display will flash to indicate that the temperature is being adjusted.

- The temperature in both upper zone and lower zone can be set independently by pressing  (warmer) or  (colder) pads that correspond to desired zone. The temperature range of both zones can be set between 39°F to 61°F (4° to 16°) +/- 5°F.
- When the pad  (warmer) or  (colder) is pressed, the temperature displayed will increase or decrease in an increment of one degree. If the pad  (warmer) or  (colder) is pressed and held for 2 seconds, the temperature displayed will increase or decrease in a speed of one degree per half second.
- Once you have adjusted the upper or lower zone to the desired temperature, release the temperature pad. At this time the temperature displayed will flash for approximately 3 seconds to confirm the selected temperature. Once the display stops flashing the temperature display will indicate the current temperature of that zone.

Note:

The temperature display can be changed between Celsius and Fahrenheit by simultaneously pressing and holding both pads  (warmer) and  (colder) for the upper zone for approximately 3 seconds. This unit cannot be in  (Lock) mode to perform this operation.

Interior Light

To turn on / off the interior lights, press the  (Light) pad. The unit cannot be in the  (Lock) mode to perform this operation. **Note: The lights will turn on / off after the touch pad is released.**

AUTOMATIC DEFROST

There is no need for manual defrosting of this appliance - it has an automatic defrosting function.

- When defrosting is in process, the indicators  for both zones will go off, and the circulation fans for both zones will run.
- Defrost water will drain out passing through the drain outlet in the inner back wall into a drain pan located above the compressor, from where it evaporates.

CARE AND MAINTENANCE

Cleaning Your Appliance

- Upon installation of your new appliance, it is recommended that it be cleaned thoroughly.
- Turn off the appliance first and then unplug the unit from the wall outlet.
- Remove all contents.
- Wash the inside with a damp warm cloth soaked in lukewarm water and baking soda solution. The solution should be about 2 tablespoons of baking soda to a quart of water.
- Be sure to keep the door gasket (seal) clean to keep the unit running efficiently.
- The outside of the appliance should be cleaned with mild detergent and warm water.
- Dry the interior and exterior with a soft cloth.
- Dust or anything else blocking the vent may hinder the cooling efficiency of the appliance. Vacuum the vent if necessary.

Moving Your Appliance

- Turn off the appliance first and then unplug the unit from the wall outlet.
- Remove all the contents.
- Securely tape down all loose items inside your appliance.
- Tape the doors shut.